

name="L
urlparam
pos="724
11"

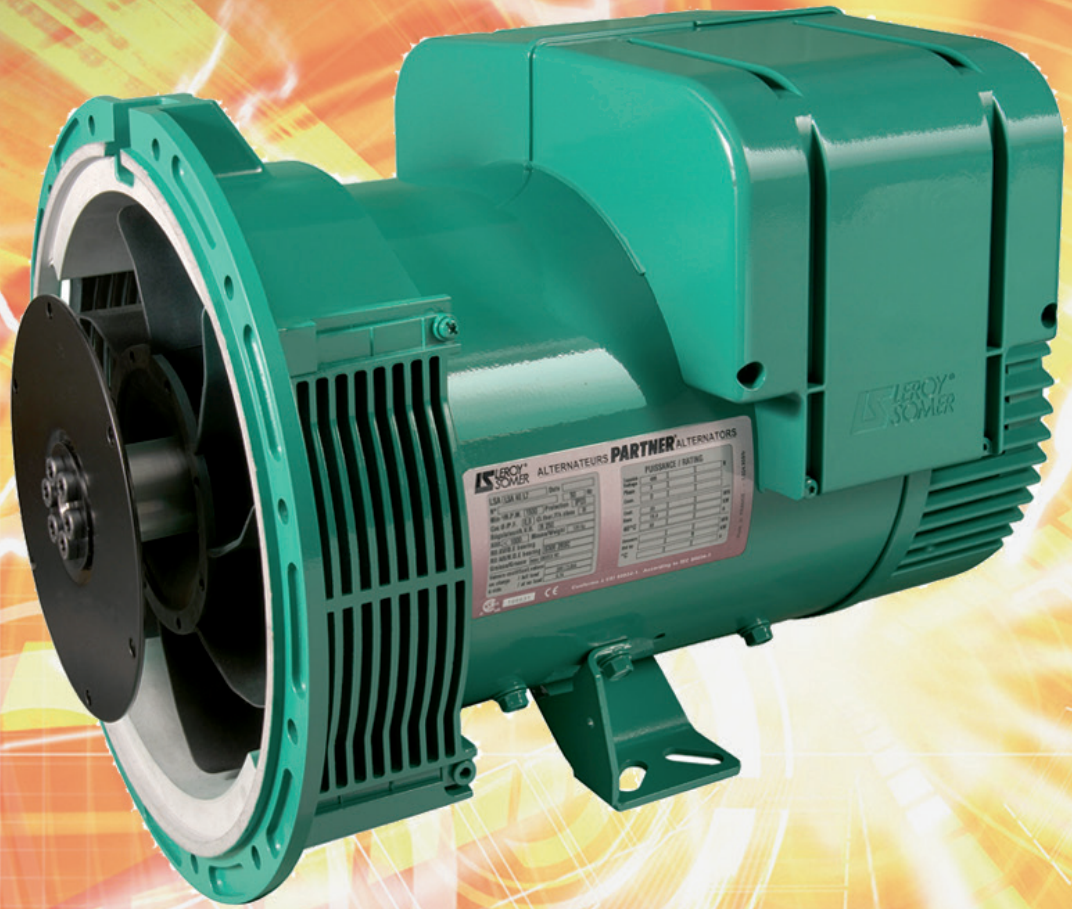

Low Voltage Alternators - 4 pole

LSA 40

10 to 20 kVA - 50 Hz / 12.5 to 25 kVA - 60 Hz
Electrical and mechanical data

Leroy-Somer™

EMERSON™
Industrial Automation

Low Voltage Alternators - 4 pole

LSA 40 - 10 to 20 kVA - 50 Hz / 12.5 to 25 kVA - 60 Hz

Specially adapted to applications

The LSA 40 alternator is designed to be suitable for typical generator applications, such as: backup, marine applications, rental, telecommunications, etc.

Compliant with international standards

The LSA 40 alternator conforms to the main international standards and regulations:

- IEC 60034, NEMA MG 1.32-33, ISO 8528-3, CSA C22.2 n°100-14, UL 1446 (UL 1004 on request), marine regulations, etc.

It can be integrated into a CE marked generator.

The LSA 40 is designed, manufactured and marketed in an ISO 9001 environment and ISO 14001.

Top of the range electrical performance

- Class H insulation.
- Standard 12-wire re-connectable winding, 2/3 pitch, type no. 6.
- Voltage range:
 - 50 Hz: 220 V - 240 V and 380 V - 415 V (440 V).
 - 60 Hz: 208 V - 240 V and 380 V - 480 V.
- High efficiency and motor starting capacity.
- Other voltages are possible with optional adapted windings:
 - 50 Hz: 440 V (no. 7), 500 V (no. 9).
 - 60 Hz: 380 V and 416 V (no. 8), 600 V (no. 9).
- R 791 interference suppression conforming to standard EN 61000-6-3, EN 61000-6-2, EN 55011 group 1 class B standard for European zone (CE marking).

Excitation and regulation system suited to the application

Excitation system			Regulation options			
Voltage regulator	SHUNT	AREP	Current transformer for paralleling	Mains paralleling	3-phase sensing	Remote voltage potentiometer
R220	Std	-	-	-	-	-
R438	-	Std	C.T.*	R726*	R731*	√
D510C*	Option	Option	C.T.*	included	included	√

√: Possible mounting

* External mounting

Protection system suited to the environment

- The LSA 40 is IP 23.
- Standard winding protection for clean environments with relative humidity $\leq 95\%$, including indoor marine environments.
Options:
 - Filters on air inlet: derating 5%.
 - Filters on air inlet and air outlet (IP 44): derating 10%.
 - Winding protections for harsh environments and relative humidity greater than 95%.
 - Space heaters.
 - Thermal protection for stator windings.
 - Steel terminal box.

Reinforced mechanical structure using finite element modelling

- Compact and rigid assembly to better withstand generator vibrations.
- Two-bearing and single-bearing versions designed to be suitable for commercially-available heat engines.
- Steel frame.
- Aluminium flanges and shields
- Half-key balancing.
- Sealed for life ball bearings.
- Direction of rotation: clockwise and anti-clockwise (without derating).

Accessible terminal box

- Easy access to the AVR and to the connections.
- 8 way terminal block for reconnecting the voltage.
- Predrilled holes for cable gland.



Low Voltage Alternators - 4 pole

LSA 40 - 10 to 20 kVA - 50 Hz / 12.5 to 25 kVA - 60 Hz

General characteristics

Insulation class	H	Excitation system	SHUNT	AREP
Winding pitch	2/3 (wdg 6)	AVR type	R 220	R 438
Number of wires	12	Voltage regulation (*)	± 1%	± 0.5%
Protection	IP 23	Short-circuit current	-	300% (3 IN): 10 s
Altitude	≤ 1000 m	Totale Harmonic distortion THD (**) in no-load : < 3% according to IEC		
Overspeed	2250 min ⁻¹	Totale Harmonic distortion THD (**) on linear load : < 5% according to IEC		
Air flow	0.06 m ³ /s, 50 Hz - 0.072 m ³ /s, 60 Hz	Waveform: NEMA = TIF (**)	< 50	

(*) Steady state. (**) Total harmonic distortion between phases, in no-load or on linear load.

Ratings 50 Hz - 1500 R.P.M.

kVA / kW - P.F. = 0.8																					
Duty/T°C	Continuous duty/40°C					Continuous duty/40°C					Stand-by/40°C					Stand-by/27°C					
Class/T°C	H/125°K					F/105°K					H/150°K					H/163°K					
Phase	3 ph.			1 ph.		3 ph.			1 ph.		3 ph.			1 ph.		3 ph.			1 ph.		
Y	380V	400V	415V	440V	ΔΔ	380V	400V	415V	440V	ΔΔ	380V	400V	415V	440V	ΔΔ	380V	400V	415V	440V	ΔΔ	
Δ	220V	230V	240V	230V		220V	230V	240V	230V		220V	230V	240V	230V		220V	230V	240V	230V		
YY	220V					220V					220V					220V					
40 VS1	kVA	10	10	10	9	7	9	9	9	8	6.5	10.5	10.5	10.5	9	7.5	11	11	11	10	8
	kW	8	8	8	7.2	5.6	7.2	7.2	7.2	6.4	5.2	8.4	8.4	8.4	7.2	6	8.8	8.8	8.8	8	6.4
40 VS2	kVA	12.5	12.5	12.5	11	9	11.5	11.5	11.5	10	8	13.5	13.5	13.5	12	9.5	14	14	14	12.5	10
	kW	10	10	10	8.8	7.2	9.2	9.2	9.2	8	6.4	10.8	10.8	10.8	9.6	7.6	11.2	11.2	11.2	10	8
40 S3	kVA	15	15	15	13	10.5	14	14	14	12	10	16	16	16	14	11.5	16.5	16.5	16.5	15	12
	kW	12	12	12	10.4	8.4	11.2	11.2	11.2	9.6	8	12.8	12.8	12.8	11.2	9.2	13.2	13.2	13.2	12	9.6
40 S4	kVA	17.5	17.5	17.5	16	12.5	16	16	16	14	11.5	19	19	19	16.5	13.5	19.5	19.5	19.5	17	14
	kW	14	14	14	12.8	10	12.8	12.8	12.8	11.2	9.2	15.2	15.2	15.2	13.2	10.8	15.6	15.6	15.6	13.6	11.2
40 M5	kVA	20	20	20	18	14	18.5	18.5	18.5	16	13	21.5	21.5	21.5	19	15	22	22	22	20	15.5
	kW	16	16	16	14.4	11.2	14.8	14.8	14.8	12.8	10.4	17.2	17.2	17.2	15.2	12	17.6	17.6	17.6	16	12.4

Ratings 60 Hz - 1800 R.P.M.

kVA / kW - P.F. = 0.8																					
Duty/T°C	Continuous duty/40°C					Continuous duty/40°C					Stand-by/40°C					Stand-by/27°C					
Class/T°C	H/125°K					F/105°K					H/150°K					H/163°K					
Phase	3 ph.			1 ph.		3 ph.			1 ph.		3 ph.			1 ph.		3 ph.			1 ph.		
Y	380V	416V	440V	480V	ΔΔ	380V	416V	440V	480V	ΔΔ	380V	416V	440V	480V	ΔΔ	380V	416V	440V	480V	ΔΔ	
Δ	220V	240V		240V		220V	240V		240V		220V	240V		240V		220V	240V		240V		
YY	208V	220V	240V			208V	220V	240V			208V	220V	240V			208V	220V	240V			
40 VS1	kVA	10	11	11.5	12.5	9	9.5	10.5	10.5	11.5	8.5	11	11.5	12.5	13.5	9.5	11.5	12	13	14	10
	kW	8.0	8.8	9.2	10.0	7.2	7.6	8.4	8.4	9.2	6.8	8.8	9.2	10	10.8	7.6	9.2	9.6	10.4	11.2	8
40 VS2	kVA	12.5	13.5	14.5	15.5	11.5	11.5	12.5	13.5	14.5	10.5	13.5	14.5	15.5	16.5	12	14	15	16	17	12.5
	kW	10.0	10.8	11.6	12.4	9.2	9.2	10	10.8	11.6	8.4	10.8	11.6	12.4	13.2	9.6	11.2	12	12.8	13.6	10
40 S3	kVA	15	16.5	17.5	19	13	14	15.5	16.5	17.5	12	16	18	19	20	13.5	17	18.5	19.5	21	14
	kW	12	13.2	14.0	15.2	10.4	11.2	12.4	13.2	14	9.6	12.8	14.4	15.2	16	10.8	13.6	14.8	15.6	16.8	11.2
40 S4	kVA	17.5	19	20	22	14.5	16.5	18	19	20.5	13	19	20.5	21.5	23.5	15	19.5	21	22	24.5	15.5
	kW	14.0	15.2	16.0	17.6	11.6	13.2	14.4	15.2	16.4	10.4	15.2	16.4	17.2	18.8	12	15.6	16.8	17.6	19.6	12.4
40 M5	kVA	20	22	23	25	16	18.5	20.5	21.5	23	15	21.5	23.5	25	27	17	22	24.5	26	27.5	17.5
	kW	16	17.6	18.4	20	12.8	14.8	16.4	17.2	18.4	12.0	17.2	18.8	20	21.6	13.6	17.6	19.6	20.8	22	14

Low Voltage Alternators - 4 pole

LSA 40 - 10 to 20 kVA - 50 Hz / 12.5 to 25 kVA - 60 Hz

Efficiencies 400 V - 50 Hz (— P.F.: 0.8) (..... P.F.: 1)

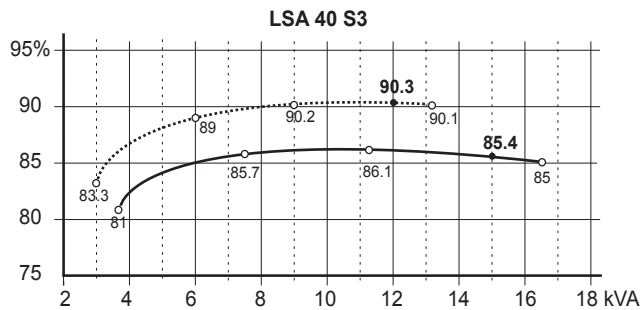
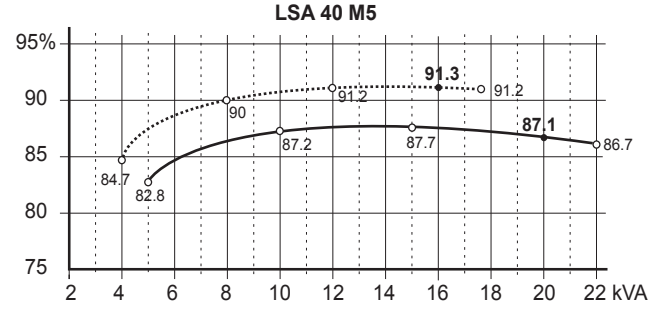
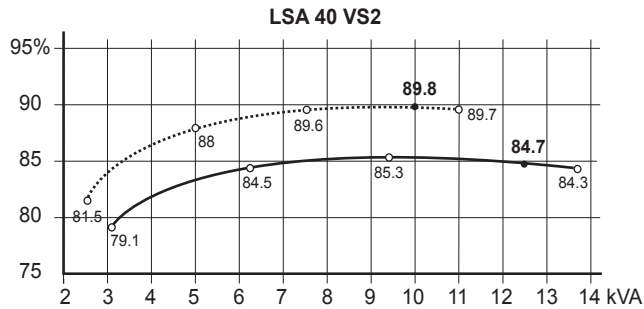
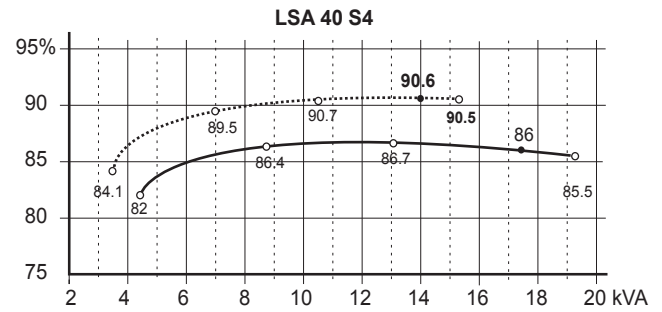
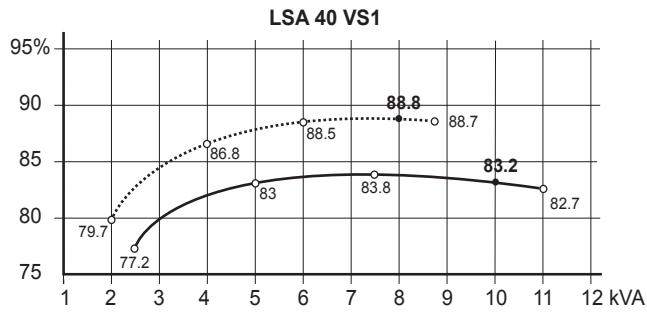

Reactances (%). Time constants (ms) - Class H / 400 V

	VS1	VS2	S3	S4	M5
Kcc Short-circuit ratio	0.72	0.69	0.62	0.62	0.63
Xd Direct-axis synchro. reactance unsaturated	167	174	190	195	193
Xq Quadrature-axis synchro. reactance unsaturated	100	104	114	117	116
T'do No-load transient time constant	780	858	909	953	1006
X'd Direct-axis transient reactance saturated	17.2	16.3	16.8	16.4	15.4
T'd Short-circuit transient time constant	74	74	74	74	74
X''d Direct-axis subtransient reactance saturated	8.6	8.1	8.4	8.2	7.7
T''d Subtransient time constant	7	7	7	7	7
X''q Quadrature-axis subtransient reactance saturated	16.1	15.9	16.8	16.8	16.2
Xo Zero sequence reactance unsaturated	0.1	0.1	0.1	0.1	0.1
X2 Negative sequence reactance saturated	12.4	12.0	12.7	12.6	12.0
Ta Armature time constant	11	11	11	11	11

Other class H / 400 V data

	VS1	VS2	S3	S4	M5
io (A) No-load excitation current (SHUNT/AREP)	0.8 / 1.1	0.8 / 1.1	0.8 / 1.1	0.8 / 1.1	0.8 / 1
ic (A) On-load excitation current (SHUNT/AREP)	2.0 / 2.7	2 / 2.8	2.1 / 2.9	2.1 / 2.9	2 / 2.7
uc (V) On-load excitation voltage (SHUNT/AREP)	25 / 18	25 / 18	26 / 19	26 / 19	24 / 18
ms Response time ($\Delta U = 20\%$ transient)	<300ms	<300ms	<300ms	<300ms	<300ms
kVA Start ($\Delta U = 20\%$ cont. or $\Delta U = 30\%$ trans.) SHUNT	25	29	36	44	52
kVA Start ($\Delta U = 20\%$ cont. or $\Delta U = 30\%$ trans.) AREP	25	29	36	44	52
% Transient ΔU (on-load 4/4) SHUNT - P.F.: 0.8 _{LAG}	< 16%	< 15.2%	< 14.7%	< 13.9%	< 13.2%
% Transient ΔU (on-load 4/4) AREP - P.F.: 0.8 _{LAG}	< 16%	< 15.2%	< 14.7%	< 13.9%	< 13.2%
W No-load losses	460	520	550	600	660
W Heat dissipation	1610	1790	2040	2270	2360

Low Voltage Alternators - 4 pole

LSA 40 - 10 to 20 kVA - 50 Hz / 12.5 to 25 kVA - 60 Hz

Transient voltage variation 400V - 50 Hz

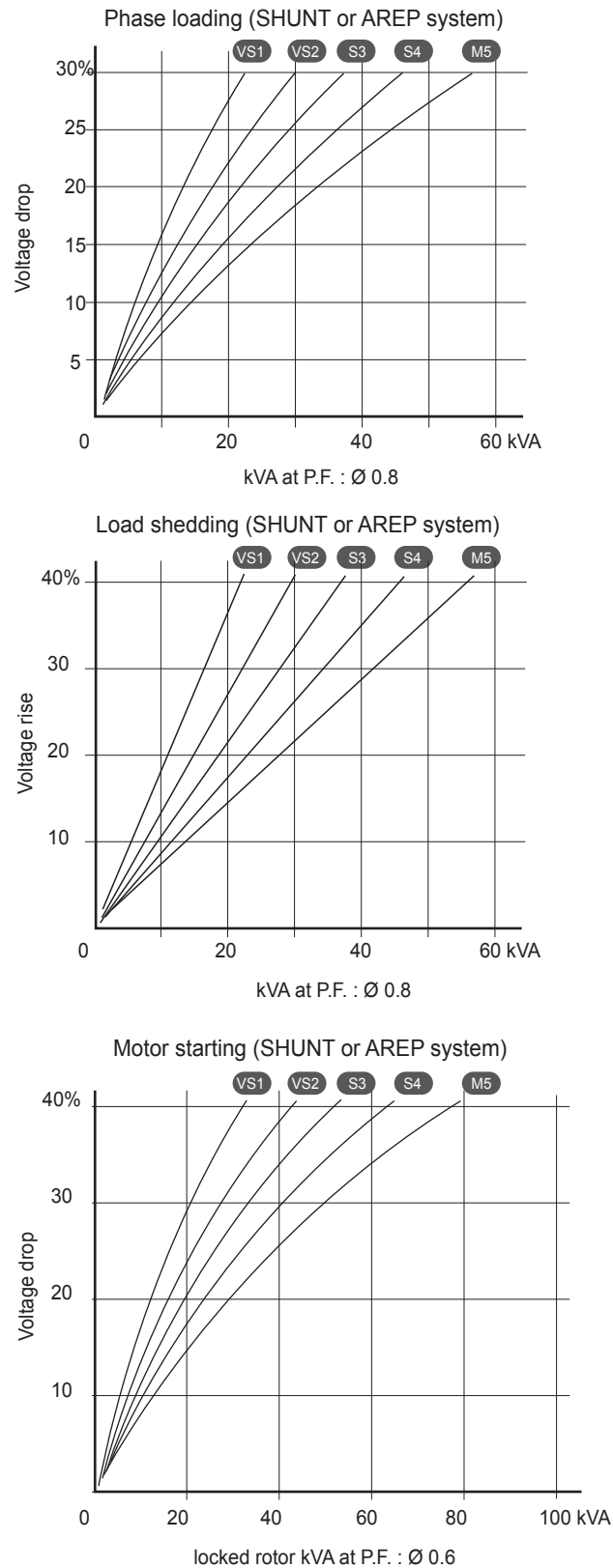

- 1) For a starting P.F. other than 0.6, the starting kVA must be multiplied by $K = \text{Sine P.F.} / 0.8$
- 2) For voltages other than 400V (Y), 230V (Δ) at 50 Hz, then kVA must be multiplied by $(400/U)^2$ or $(230/U)^2$.

Low Voltage Alternators - 4 pole

LSA 40 - 10 to 20 kVA - 50 Hz / 12.5 to 25 kVA - 60 Hz

Efficiencies 480 V - 60 Hz (— P.F.: 0.8) (..... P.F.: 1)

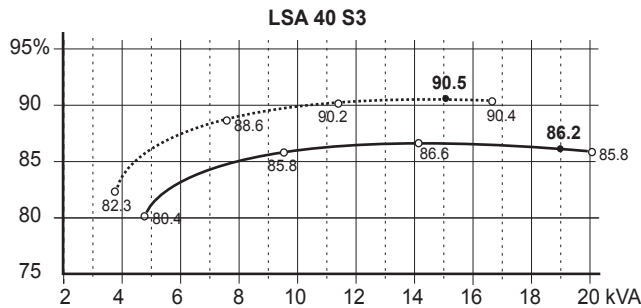
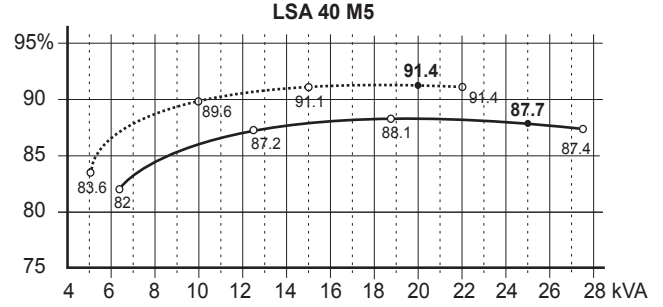
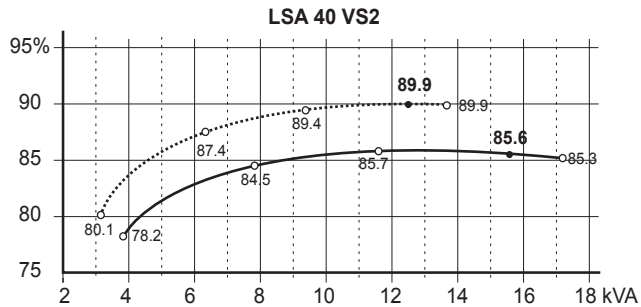
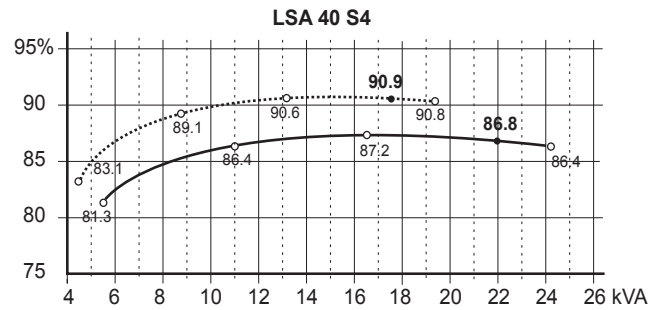
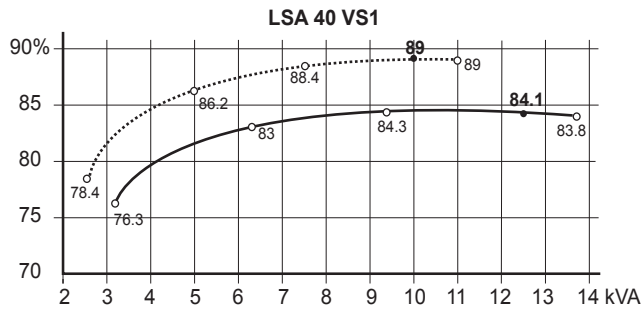

Reactances (%). Time constants (ms) - Class H / 480 V

	VS1	VS2	S3	S4	M5
Kcc Short-circuit ratio	0.69	0.67	0.59	0.59	0.61
Xd Direct-axis synchro. reactance unsaturated	174	180	201	204	201
Xq Quadrature-axis synchro. reactance unsaturated	104	108	120	122	121
T'do No-load transient time constant	780	858	909	953	1006
X'd Direct-axis transient reactance saturated	17.9	16.8	17.8	17.2	16.1
T'd Short-circuit transient time constant	74	74	74	74	74
X''d Direct-axis subtransient reactance saturated	8.9	8.4	8.9	8.6	8.0
T''d Subtransient time constant	7	7	7	7	7
X''q Quadrature-axis subtransient reactance saturated	16.7	16.4	17.8	17.6	16.9
Xo Zero sequence reactance unsaturated	0.1	0.1	0.1	0.1	0.1
X2 Negative sequence reactance saturated	12.9	12.4	13.4	13.1	12.5
Ta Armature time constant	11	11	11	11	11

Other class H / 480 V data

	VS1	VS2	S3	S4	M5
io (A) No-load excitation current (SHUNT/AREP)	0.8 / 1.1	0.8 / 1.1	0.8 / 1.1	0.8 / 1.1	0.8 / 1
ic (A) On-load excitation current (SHUNT/AREP)	2.0 / 2.8	2.0 / 2.8	2.2 / 2.9	2.2 / 2.9	2.0 / 2.8
uc (V) On-load excitation voltage (SHUNT/AREP)	25 / 18	25 / 18	26 / 19	26 / 19	25 / 18
ms Response time ($\Delta U = 20\%$ transient)	<300ms	<300ms	<300ms	<300ms	<300ms
kVA Start ($\Delta U = 20\%$ cont. or $\Delta U = 30\%$ trans.) SHUNT	30	35	43	53	62
kVA Start ($\Delta U = 20\%$ cont. or $\Delta U = 30\%$ trans.) AREP	30	35	43	53	62
% Transient ΔU (on-load 4/4) SHUNT - P.F.: 0.8 _{LAG}	< 16.4%	< 15.4%	< 15.2%	< 14.3%	< 13.5%
% Transient ΔU (on-load 4/4) AREP - P.F.: 0.8 _{LAG}	< 16.4%	< 15.4%	< 15.2%	< 14.3%	< 13.5%
W No-load losses	650	730	770	840	920
W Heat dissipation	1880	2080	2420	2670	2780

Low Voltage Alternators - 4 pole

LSA 40 - 10 to 20 kVA - 50 Hz / 12.5 to 25 kVA - 60 Hz

Transient voltage variation 480V - 60 Hz

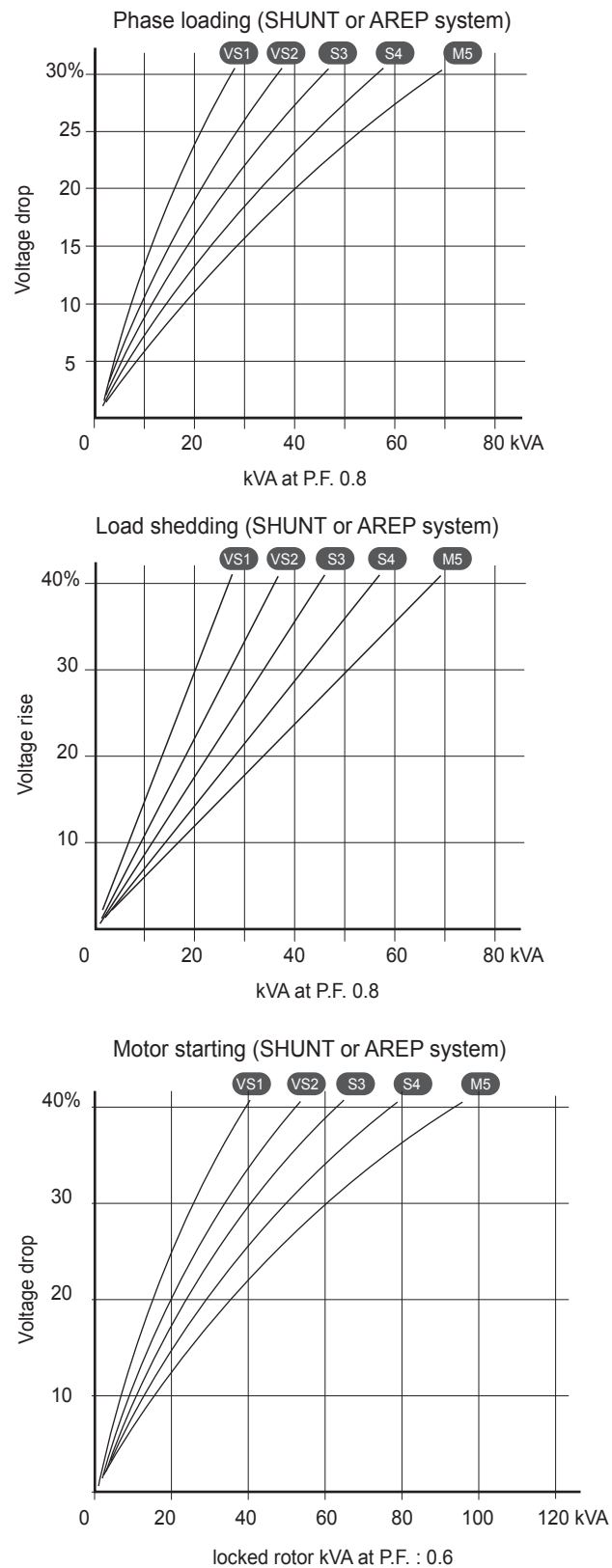

- 1) For a starting P.F. other than 0.6, the starting kVA must be multiplied by $K = \text{Sine P.F.} / 0.8$
- 2) For voltages other than 480V (Y), 277V (Δ), 240V (YY) at 60 Hz, then kVA must be multiplied by $(480/U)^2$ or $(277/U)^2$ or $(240/U)^2$.

Low Voltage Alternators - 4 pole

LSA 40 - 10 to 20 kVA - 50 Hz / 12.5 to 25 kVA - 60 Hz

3-phase short-circuit curves at no load and rated speed (star connection Y)

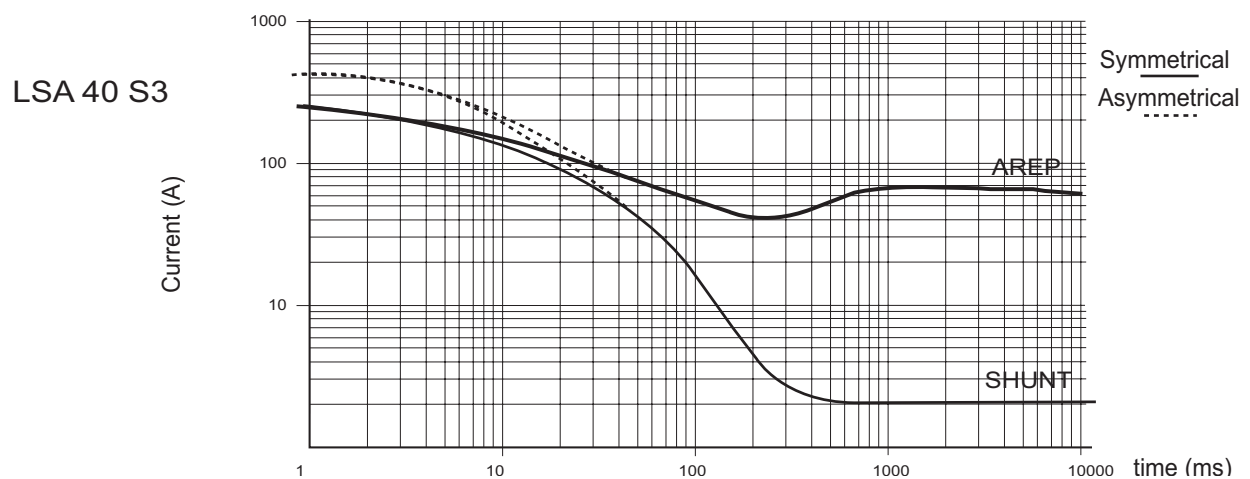
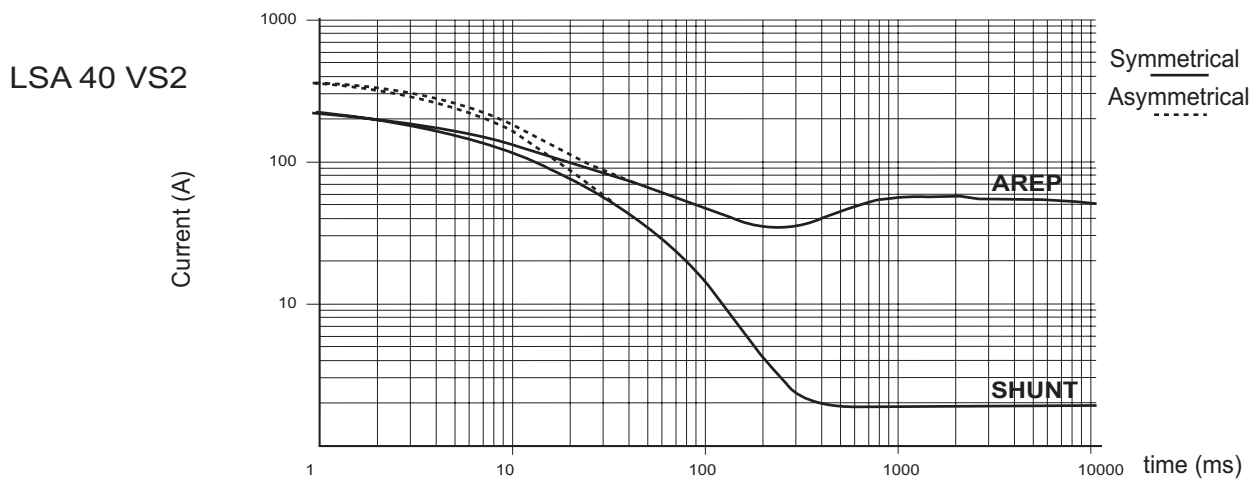
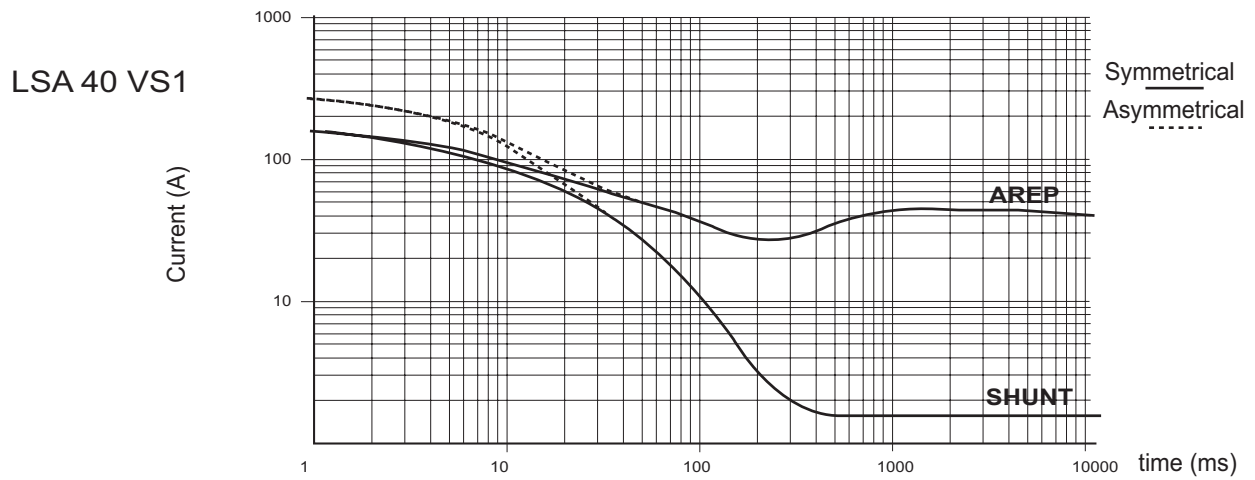

Influence due to connection

Curves shown are for star (Y) connection.

For other connections, use the following multiplication factors:

- Series delta : current value x 1.732 - Parallel star : current value x 2

Low Voltage Alternators - 4 pole

LSA 40 - 10 to 20 kVA - 50 Hz / 12.5 to 25 kVA - 60 Hz

3-phase short-circuit curves at no load and rated speed (star connection Y)

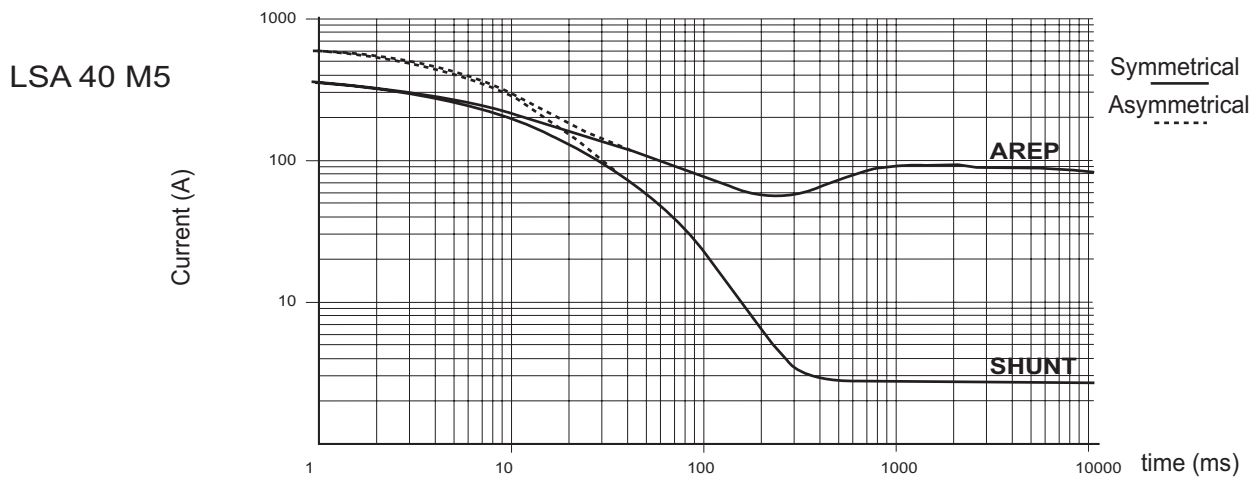
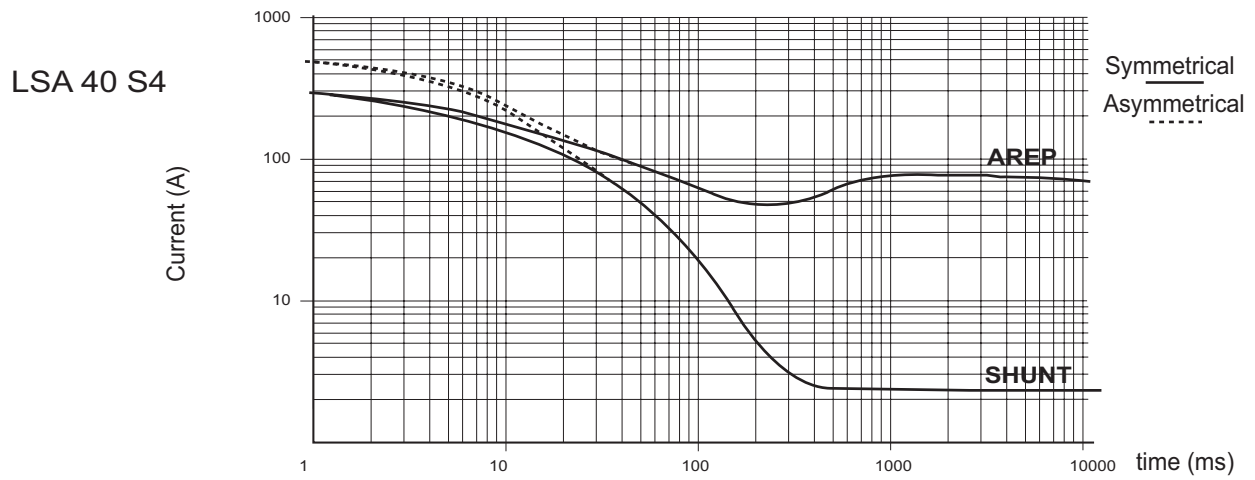

Influence due to short-circuit

Curves are based on a three-phase short-circuit.

For other types of short-circuit, use the following multiplication factors.

	3-phase	2-phase L/L	1-phase L/N
Instantaneous (max.)	1	0.87	1.3
Continuous	1	1.5	2.2
Maximum duration (AREP/PMG)		1.5	

Low Voltage Alternators - 4 pole

LSA 40 - 10 to 20 kVA - 50 Hz / 12.5 to 25 kVA - 60 Hz

Single bearing dimensions

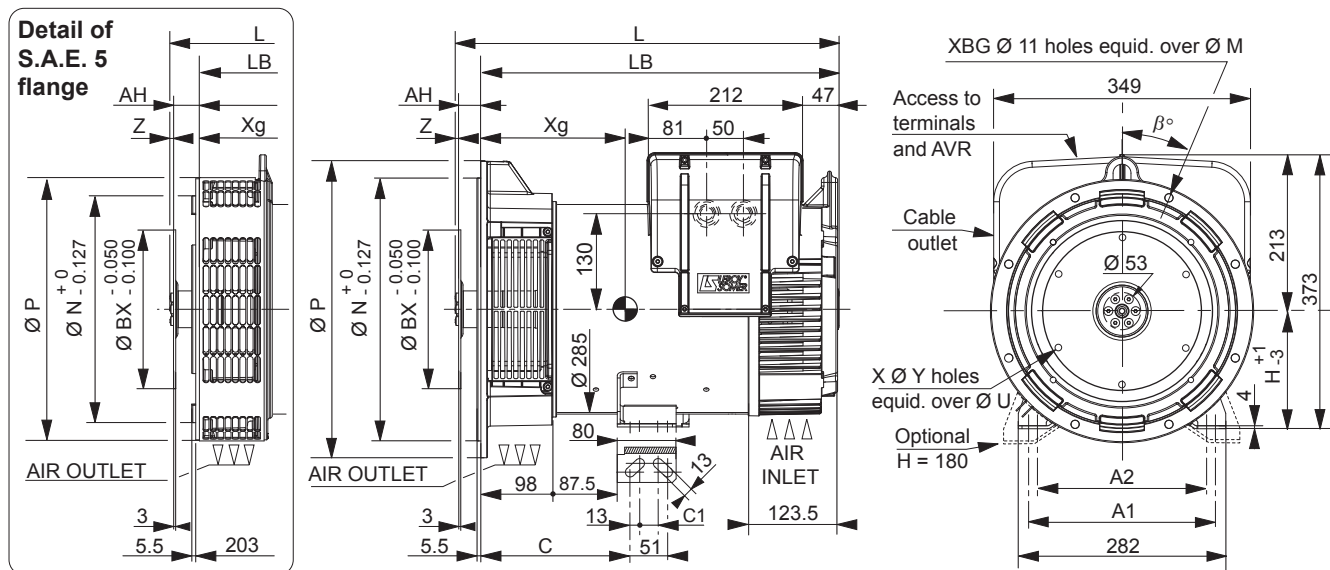

Dimensions (mm) and weight				
Type	L maxi *	LB	Xg	Weight (kg)
LSA 40 VS1	467	405	186	73
LSA 40 VS2	467	405	196	80
LSA 40 S3	497	435	204	87
LSA 40 S4	497	435	221	92
LSA 40 M5	517	455	221	102

	Standard	Option	Coupling			
	Hauteur d'axe		Flange	3	4	5
H	160	180	11 1/2	x	-	-
Feet length						
C	203	238	10	x	x	-
C1	25	22	8	x	x	-
A1	254	279	7 1/2	-	x	x
A2	230	-	6 1/2	-	x	x

Flange (mm)					
S.A.E.	P	N	M	XBG	β°
5	358	314.32	333.38	8	22°30
4	408	361.95	381	12	15°
3	460	409.58	428.62	12	15°

Flex plate (mm)						
S.A.E.	BX	U	X	Y	AH	Z
11 1/2	352.42	333.38	8	11	39.6	0
10	314.32	295.28	8	11	53.8	0
8	263.52	244.48	6	11	62	0
7 1/2	241.3	222.25	8	9	30.2	4.5
6 1/2	215.9	200.02	6	9	30.2	4.5

* L maxi = LB + AH maxi

Torsional analysis data

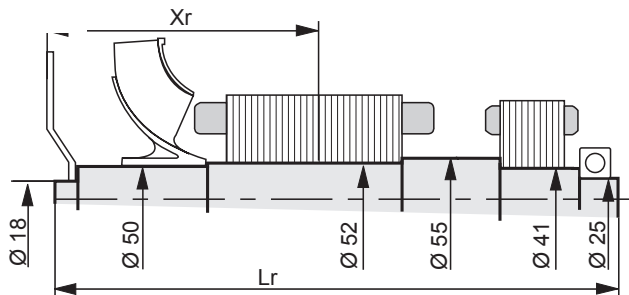

Centre of gravity: Xr (mm), Rotor length: Lr (mm), Weight: M (kg), Moment of inertia: J (kgm ²): (4J = MD ²)																				
Type	Flex plate S.A.E. 6 1/2				Flex plate S.A.E. 7 1/2				Flex plate S.A.E. 8				Flex plate S.A.E. 10				Flex plate S.A.E. 11 1/2			
	Xr	Lr	M	J	Xr	Lr	M	J	Xr	Lr	M	J	Xr	Lr	M	J	Xr	Lr	M	J
LSA 40 VS1	211.7	428	25.54	0.0779	211.7	428	25.7	0.0802	243.5	428	26	0.0847	238.3	428	26.5	0.0964	221.1	428	27	0.1080
LSA 40 VS2	221.7	428	27.95	0.0867	221.7	428	28.11	0.0890	253.5	428	28.41	0.0935	248.3	428	28.91	0.1052	231.1	428	29.41	0.1168
LSA 40 S3	229.2	458	30.32	0.0936	229.2	458	30.48	0.0959	261	458	30.78	0.1004	255.8	458	31.28	0.1121	238.6	458	31.78	0.1237
LSA 40 S4	236.7	458	32.23	0.1004	236.7	458	32.39	0.1027	268.5	458	32.69	0.1072	263.3	458	33.19	0.1189	246.1	458	33.69	0.1305
LSA 40 M5	246.7	478	35.26	0.1102	246.7	478	35.42	0.1125	278.5	478	35.72	0.1170	273.3	478	36.22	0.1287	256.1	478	36.72	0.1403

NOTE : Dimensions are for information only and may be subject to modifications. Contractuel 2D drawings can be downloaded from the Leroy-Somer site, 3D drawing files are available upon request.
The torsional analysis of the transmission is imperative. All values are available upon request.

Low Voltage Alternators - 4 pole

LSA 40 - 10 to 20 kVA - 50 Hz / 12.5 to 25 kVA - 60 Hz

Two bearing dimensions

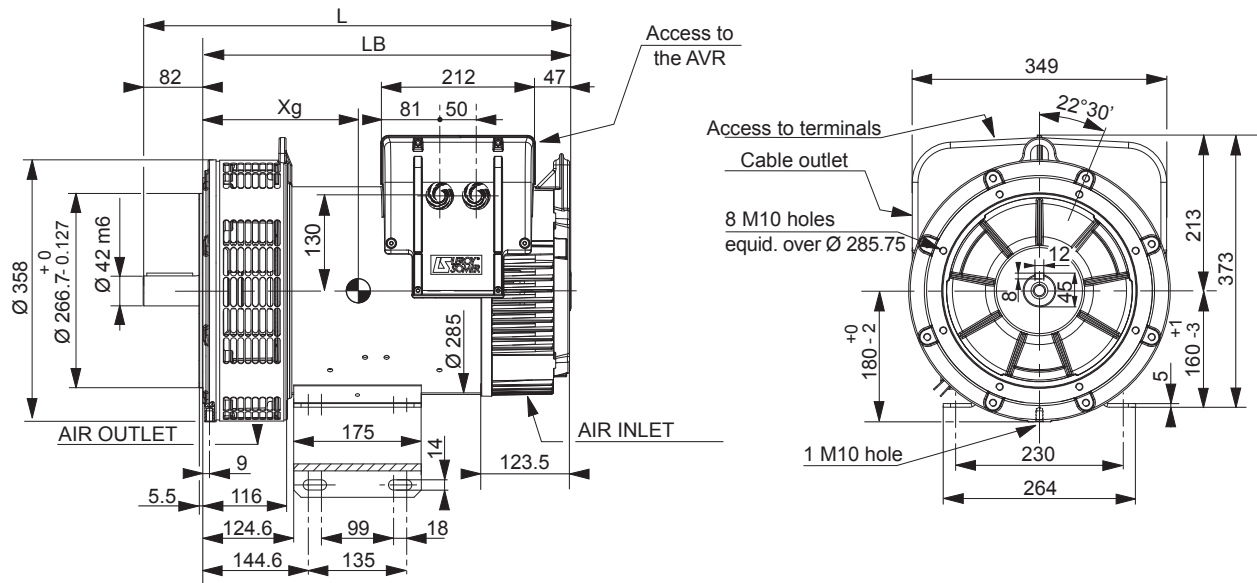

Dimensions (mm)				
Type	L	LB	Xg	Weight (kg)
LSA 40 VS1	505	423	198	82
LSA 40 VS2	505	423	208	89
LSA 40 S3	535	453	216	96
LSA 40 S4	535	453	233	101
LSA 40 M5	555	473	233	109

Torsional analysis data

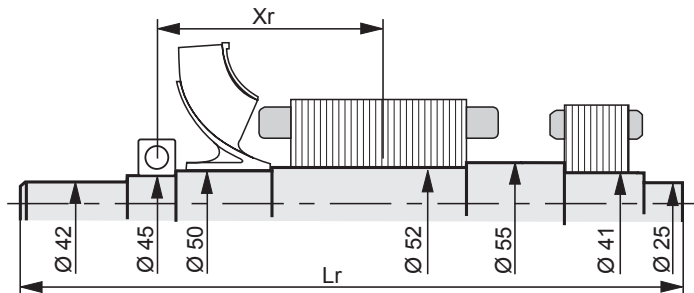

Centre of gravity: Xr (mm), Rotor length: Lr (mm), Weight: M (kg), Moment of inertia: J (kgm ²): (4J = MD ²)				
Type	Xr	Lr	M	J
LSA 40 VS1	176.5	450.2	25.38	0.0731
LSA 40 VS2	186.5	450.2	27.79	0.0819
LSA 40 S3	194	480.2	30.16	0.0888
LSA 40 S4	201.5	480.2	32.07	0.0956
LSA 40 M5	211.5	500.2	35.10	0.1054

NOTE : Dimensions are for information only and may be subject to modifications. Contractuel 2D drawings can be downloaded from the Leroy-Somer site, 3D drawing files are available upon request.
The torsional analysis of the transmission is imperative. All values are available upon request.

EMERSON. CONSIDER IT SOLVED.™

www.emersonindustrial.com

© Emerson 2014. The information contained in this brochure is for guidance only and does not form part of any contract. The accuracy cannot be guaranteed as Emerson have an ongoing process of development and reserve the right to change the specification of their products without notice.

Moteurs Leroy-Somer SAS. Headquarters: Bd Marcellin Leroy, CS 10015, 16915 Angoulême Cedex 9, France. Share Capital: 65 800 512 €, RCS Angoulême 338 567 258.

Leroy-Somer™

EMERSON™
Industrial Automation